



58.103

## Viewlite monitor arm - desk 103

The proximity of monitor and pole makes this is an ideal, compact POS (Point Of Sale) solution. Stepless height adjustment lets each user find their own optimal ergonomic position. Cables are easily hidden in the aluminium pole to create a tidy, professional impression.

- Static height adjustment range of 350 mm (13,8")
- Fixed depth
- Integrated cable management
- Main components made of aluminium
- 40% of aluminium content is already recycled
- VESA MIS-D 75 x 75/100 x 100 mm compatible
- Monitor: tilt +65°/-65°, swivel 360°, rotate 360°
- Weight capacity max. 8 kg (17,6 lb) per monitor
- Comes with a desk clamp mount and bolt-through desk mount
- Suitable for a desktop thickness of 5 up to 40 mm (0,2" - 1,6") (clamp) or 50 mm (2,0") (bolt through)
- Monitor size limit: height 816 mm (32,1")
- Fitted with a practical quick-release VESA system
- Monitor rotation lock can be enabled

# viewlite

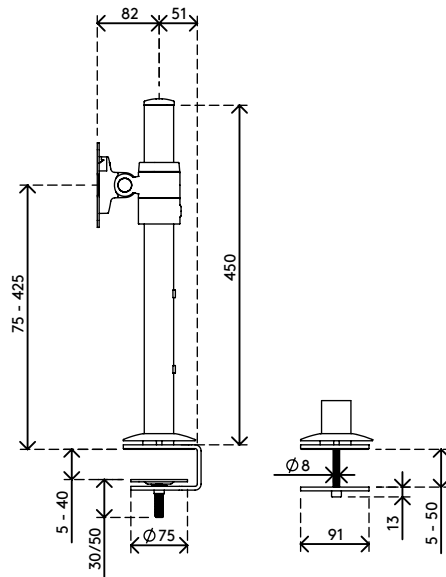
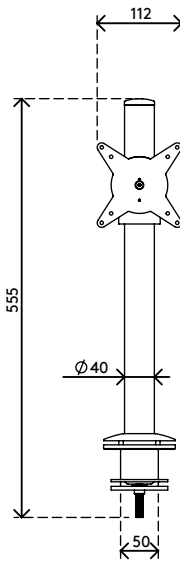
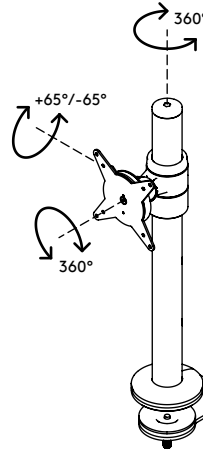
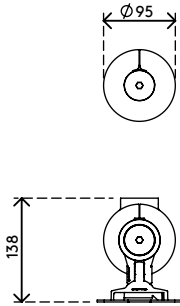

350 mm (13,8")



+65°/-65°

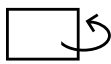

360°



360°

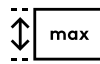

816 mm (32,1")



75 x 75/100 x 100



8 kg (17,6 lb)

## Viewlite monitor arm - desk 103

2020/10/06

# 58.103

 610 x 180 x 120 mm

 1 pcs

 black

 3 kg

 805410581039