

viewmaster^x

Warranty

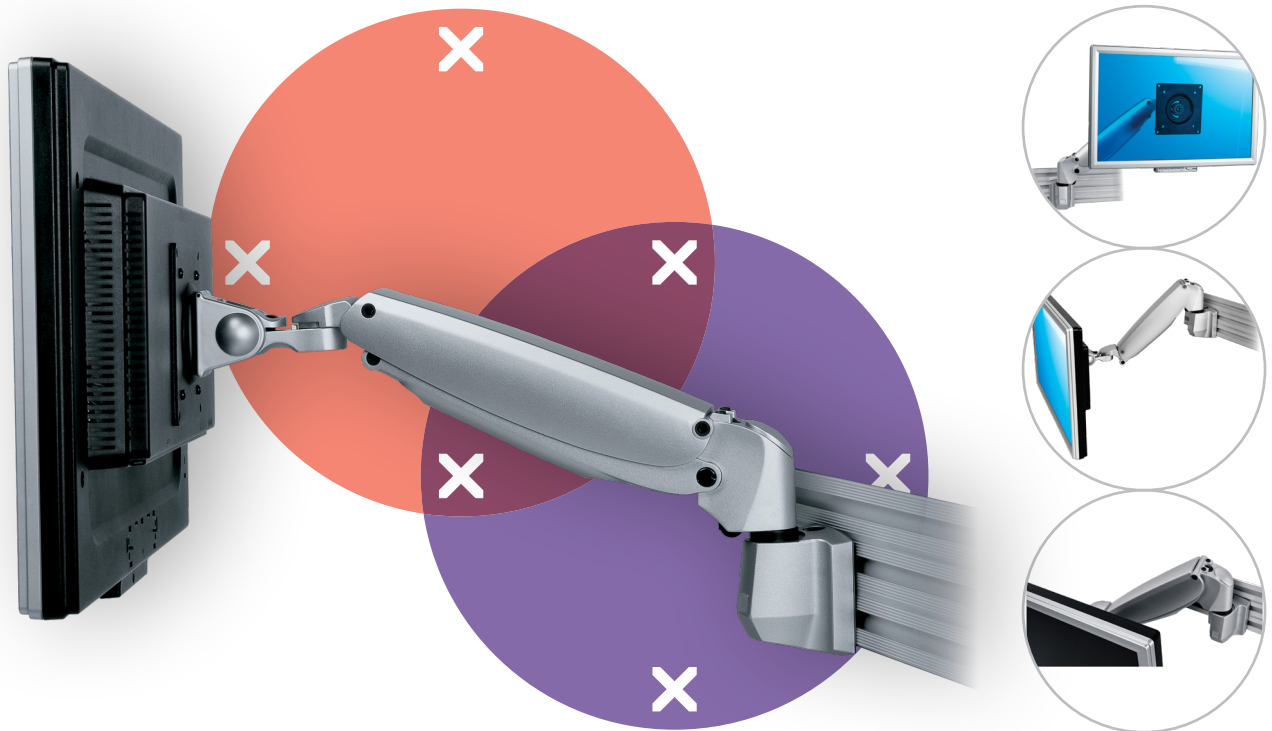

57.102

Viewmaster monitor arm - rail 102

A high-end design that mounts lighter monitors to a slat rail or toolbar. The clamping mechanism can be tightened or loosened simply by adjusting a screw on top. Tilt, swivel, rotate and smoothly adjust your monitor in height using just your fingertips to set it into an ergonomic position.

- Dynamic height adjustment range of 305 mm (12,0")
- Dependent depth adjustment
- Partly integrated or concealed cable management
- Main components made of aluminium
- VESA MIS-D 75 x 75/100 x 100 mm compatible
- Monitor: tilt +90°/-90°, swivel +90°/-90°, rotate +90°/-90°
- Arm: swivel 360°
- Weight capacity min. 2,3 - max. 6,8 kg (5,1 - 15 lb) per monitor
- Comes with a rail mount
- Protective nylon surface on mount ensures smooth sliding
- Mount fitted with hardened steel clamping brackets
- Built-in SUSPA® gas spring
- Listed weight capacity will vary when mounting monitors that are deeper than 25 mm (1,0") or have an off-centre VESA mount position

dataflex^x

feeling at work

viewmaster

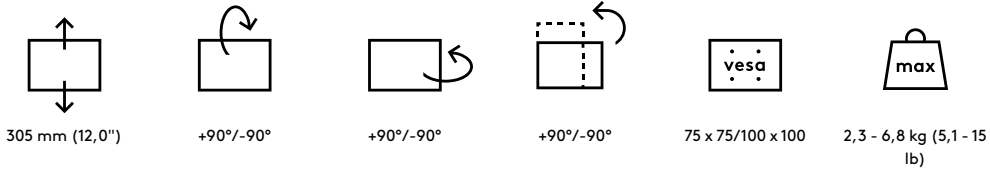
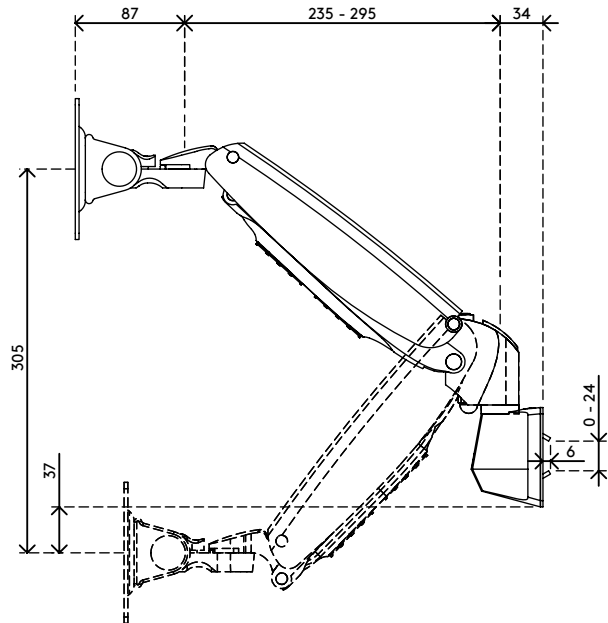
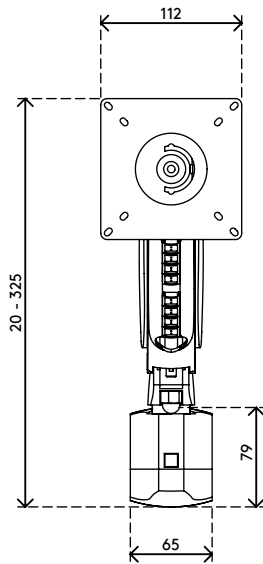
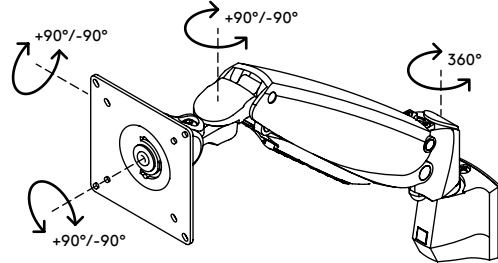
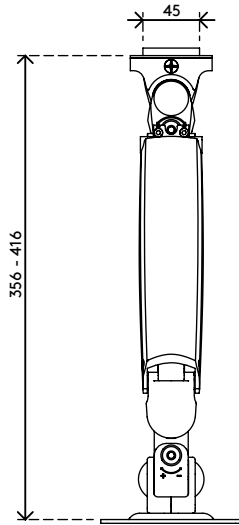

Viewmaster monitor arm - rail 102

2020/10/06

57.102

 465 x 135 x 120 mm

 1 pcs

 silver

 2,55 kg

 805410571023