

53.443







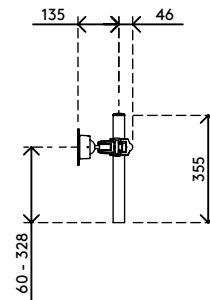
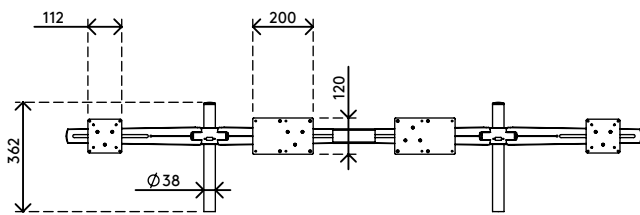
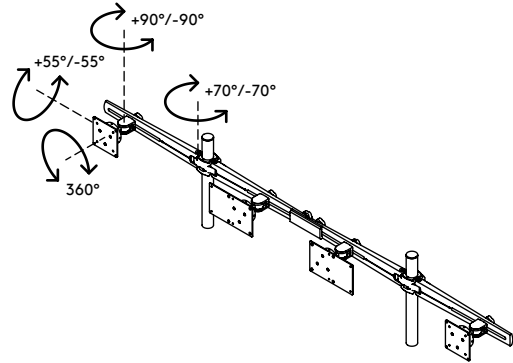
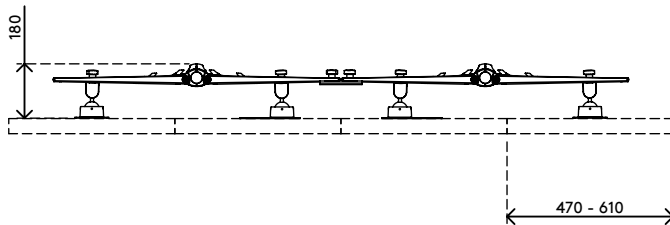

Viewmaster multi-monitor system - desk 443

This model mounts 4 monitors in a row. Like on all other winged multi-monitor systems, each monitor can be adjusted individually. Cable management in the wings tidies up all cables, resulting in an impressive, curved set-up.

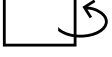
- Stepless height adjustment
- For 4 monitors
- Cable clips and loop ties included
- Die-cast aluminium parts
- VESA MIS-D 75 x 75/100 x 100 mm compatible
- Monitor: tilt +55°/-55°, swivel +90°/-90°, rotate 360°
- Weight capacity max. 12 kg (26,5 lb) per monitor
- Desk mounts not included
- Monitor size limit: width 610 mm (24,0") - height 618 mm (24,3")
- Due to excellent stability also suitable for touchscreens

viewmaster x



- 
 268 mm (10,6")
- 
 +55°/-55°
- 
 +90°/-90°
- 
 360°
- 
 610mm (24,0")
- 
 618 mm (24,3")
- 
 75 x 75/100 x 100
- 
 (4x) 12 kg (26,5 lb)

Viewmaster multi-monitor system - desk 443

2020/10/06

53.443

 740 x 395 x 122 mm

 1 pcs

 black

 12,276 kg

 805410534431