

viewmaster^x

Warranty

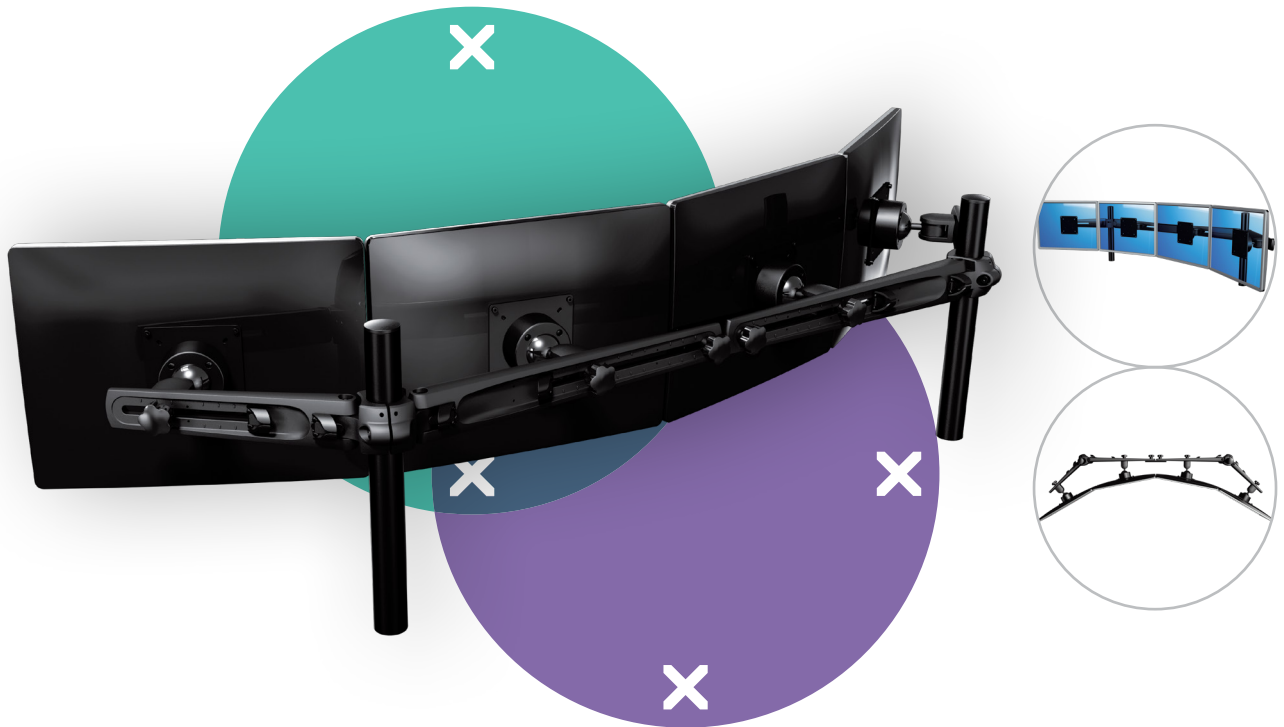

53.433

Viewmaster multi-monitor system - desk 433

This model mounts 4 monitors in a row. Like on all other winged multi-monitor systems, each monitor can be adjusted individually. Cable management in the wings tidies up all cables, resulting in an impressive, curved set-up.

- Stepless height adjustment
- For 4 monitors
- Cable clips and loop ties included
- Die-cast aluminium parts
- VESA MIS-D 75 x 75/100 x 100 mm compatible
- Monitor: tilt +55°/-55°, swivel +90°/-90°, rotate 360°
- Weight capacity max. 12 kg (26,5 lb) per monitor
- Desk mounts not included
- Monitor size limit: width 500 mm (19,7") - height 428 mm (16,8")
- Due to excellent stability also suitable for touchscreens

dataflex

feeling at work

viewmaster

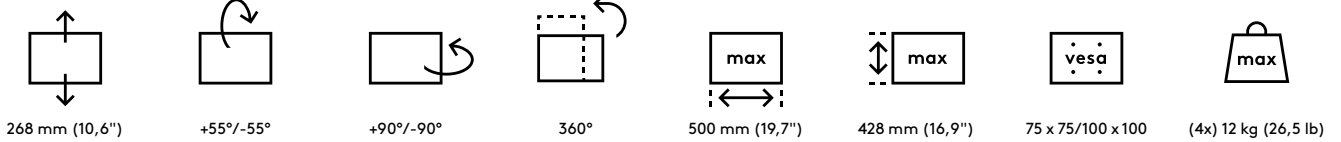
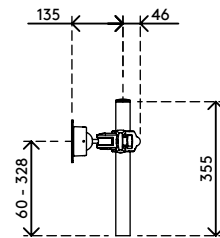
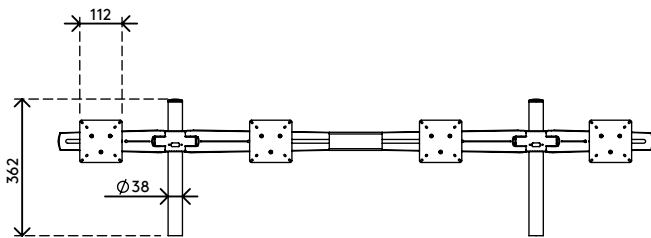
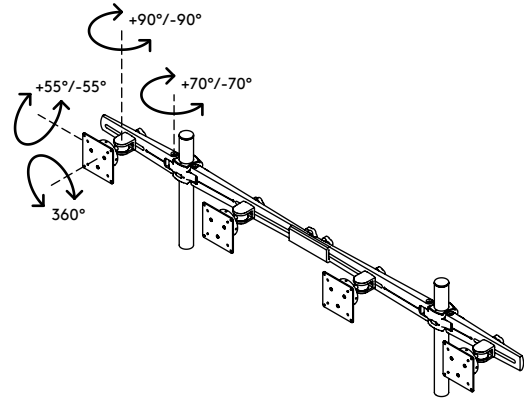
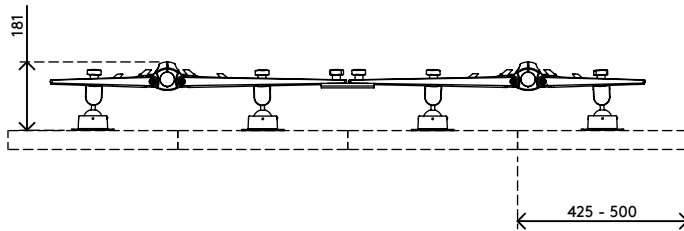

Viewmaster multi-monitor system - desk 433

2020/10/06

53.433

 740 x 395 x 122 mm

 1 pcs

 black

 10,3 kg

 805410534332